

GB

IT

DE

FR

ES

OPERATING MANUAL

MANUALE D'ISTRUZIONE

BETRIEBSANLEITUNG

MANUEL D'INSTRUCTION

MANUAL DE USO



**MULTI-PROCESS MIG/MAG,
MMA, TIG WELDER**

**SALDATRICE MULTI-PROCESSO
MIG/MAG, MMA, TIG**

**MULTIFUNKTIONS-SCHWEISSINVERTER
MIG/MAG, MMA, WIG**

**ONDULEUR DE SOUDAGE MULTIFONCTION
MIG/MAG, MMA, TIG**

**SOLDADORA MULTIPROCESO
MIG/MAG, MMA, TIG**

CE



1.0 SAFETY INFORMATION	4		
1.1 INTRODUCTION	4		
1.2 PERSONAL PROTECTION	4		
1.3 FIRE PREVENTION	4		
1.4 ELECTRIC SHOCK	4		
1.5 NOISE	5		
1.6 ELECTROMAGNETIC COMPATIBILITY	5		
1.7 PROTECTIVE WELDING GASES	5		
2.0 INSTALLATION RECOMMENDATIONS	5		
2.1 LOCATION	5		
2.2 VENTILATION	6		
2.3 MAIN SUPPLY VOLTAGE REQUIREMENTS	6		
2.4 SAFETY INSTRUCTIONS	6		
3.0 INTRODUCTION	6		
4.0 KNOW YOUR WELDER	7		
QUICK START	7		
CONTROLS AND OPERATIONAL FEATURES	8		
5.0 STICK ELECTRODE WELDING (SMAW)	10		
5.1 GETTING READY FOR STICK ELECTRODE WELDING (SMAW).	10		
6.0 TIG WELDING WITH LIFT START (GTAW)	10		
6.1 SETTING UP THE EQUIPMENT FOR TIG WELDING	10		
7.0 MIG (GMAW) AND FLUX CORE (FCAW) WELDING	11		
7.1.1 TORCH CONNECTION	11		
7.1.2 WIRE LOADING	11		
7.1.3 REPLACING THE WIRE LINER	12		
7.1.4 HOW TO CHOOSE THE WIRE LINER	12		
7.1.5 GAS CYLINDER AND REGULATOR CONNECTION	12		
7.1.6 FLUXCORE WIRE WELDING, "FCAW"	12		
7.1.7 MIG WELDING, "GMAW"	12		
7.2 MIG / NO GAS MANUAL WELDING	13		
7.3 SYNERGIC MIG WELDING	13		
7.4 ALUMINUM WELDING	13		
8.0 PROTECTION GASES GUIDE	14		
9.0 WELDING HINTS AND MAINTENANCE	14		
10.0 TROUBLESHOOTING	15		
ITALIANO			
1.0 NORME DI SICUREZZA	18		
1.1 INTRODUZIONE	18		
1.2 SICUREZZA PERSONALE	18		
1.3 PREVENZIONE DI INCENDIO	18		
1.4 SHOCK ELETTRICO	18		
1.5 RUMORI	19		
1.6 COMPATIBILITA' ELETTROMAGNETICA	19		
1.7 GAS DI PROTEZIONE	19		
2.0 RACCOMANDAZIONI PER L'INSTALLAZIONE	19		
2.1 COLLOCAZIONE	19		
2.2 VENTILAZIONE	20		
2.3 REQUISITI DELLA TENSIONE DI RETE	20		
2.4 ISTRUZIONI PER LA SICUREZZA	20		
3.0 INTRODUZIONE	20		
4.0 LA VOSTRA SALDATRICE	21		
5.0 SALDATURA AD ELETTRODO (SMAW)	24		
5.1 COLLEGAMENTO E PREPARAZIONE	24		
6.0 SALDATURA A TIG (GTAW)	24		
6.1 COLLEGAMENTO E PREPARAZIONE	24		
6.2 INNESCO DELL'ARCO PER CONTATTO (LIFT ARC)	24		
7.0 SALDATURA A FILO CONTINUO MIG/MAG (FCAW), MOG (GMAW)	24		
7.1.1 COLLEGAMENTO TORCIA	24		
7.1.2 CARICAMENTO FILO	24		
7.1.3 SOSTITUZIONE DELLA GUAINA GUIDAFILO	26		
7.1.4 SCELTA DELLA GUAINA GUIDAFILO	26		
7.1.5 COLLEGAMENTO BOMBOLA GAS E RIDUTTORE	26		
7.1.6 SALDATURA A FILO CONTINUO SENZA GAS (FCAW)	26		
7.1.7 SALDATURA A FILO CONTINUO CON GAS (GMAW)	26		
7.2 SALDATURA MIG/MAG E NO GAS IN MODALITA' MANUALE (RIF. FIGURA 1)	27		
7.3 SALDATURA MIG E NO GAS IN MODALITA' SINERGICA (RIF. FIGURA 1)	27		
7.4 SALDATURA DELL'ALLUMINIO	27		
8.0 GUIDA AI GAS DI PROTEZIONE	28		
9.0 SUGGERIMENTI PER LA SALDATURA E LA MANUTENZIONE	28		
10.0 INDIVIDUAZIONE ED ELIMINAZIONE DI GUASTI ED INCONVENIENTI	29		
DEUTSCH			
1.0 SICHERHEITSVORSCHRIFTEN	32		
1.1 EINLEITUNG	32		
1.2 SICHERHEIT DES PERSONALS	32		
1.3 BRANDSCHUTZ	32		
1.4 ELEKTRISCHER SCHLAG	32		
1.5 LÄRM	33		
1.6 ELEKTROMAGNETISCHE VERTRÄGLICHKEIT	33		
1.7 SCHUTZGAS	33		
2.0 VORSCHRIFTEN FÜR DIE INSTALLATION	34		
2.1 AUFSTELLUNG	34		
2.2 LÜFTUNG	34		
2.3 NETZANSCHLUSS	34		
4.0 EINFÜHRUNG	36		
5.0 E-HAND SCHWEISSEN (MMA)	38		
5.1 VORBEREITUNG ZUM E-HAND SCHWEISSEN (MMA)	38		
6.0 WIG SCHWEISSEN MIT LIFT-ARC ZÜNDUNG (GTAW)	38		
6.1 VORBEREITUNG ZUM WIG SCHWEISSEN (GTAW)	38		
6.2 SCHLIESSEN SIE DAS VENTIL IM BRENNER-HANDGRIFF	38		
6.3 BERÜHRUNGSZÜNDEN DES WIG-LICHTBOGEN	38		
7.0 MIG/ MAG (GMAW) UND FÜLLDRAHT (FCAW) SCHWEISSEN	39		
7.1.1 BRENNERANSCHLUSS	39		
7.1.2 DRAHT EINLEGEN	39		
7.1.3 AUSTAUSCHEN DER DRAHTFÜHRUNGSSEELE	40		
7.1.4 AUSFÜHRUNGEN DER DRAHTFÜHRUNGSSEELE	40		
7.1.5 GASFLASCHEN UND DRUCKMINDERER	40		
7.1.6 FÜLLDRAHT SCHWEISSEN, "FCAW"	40		
7.1.7 MIG/ MAG SCHWEISSEN, "GMAW"	40		
7.2 MIG MANUAL SCHWEISSEN	41		
7.3 SYNERGIESCHES SCHWEISSEN	41		
7.4 ALUMINIUM SCHWEISSEN	41		
8.0 SCHUTZGAS ARTEN	42		
9.0 SCHWEISSWISSEN	42		
10.0 FEHLERSUCHE	43		
FRANÇAIS			
1.0 RÈGLES DE SECURITE	45		
1.1 INTRODUCTION	45		
1.2 SECURITE DU PERSONNEL	45		
1.3 PREVENTION CONTRE L'INCENDIE	45		
1.4 ELECTROCUTION	45		
1.5 BRUITS	46		
1.6 COMPATIBILITE ELECTROMAGNETIQUE	46		
1.7 GAZ PROTECTEURS	46		
2.0 RECOMMANDATIONS POUR L'INSTALLATION	46		
2.1 MISE EN PLACE	46		
2.2 AERATION	47		
2.3 CONDITIONS REQUISES POUR LA TENSION DU RESEAU	47		
2.4 INSTRUCTIONS POUR LA SECURITE	47		
3.0 INTRODUCTION	47		
4.0 VOTRE POSTE A SOUDER - COMMENT IL TRAVAILLE	48		
CONTRÔLES ET CARACTÉRISTIQUES OPÉRATIONNELLES	49		
5.0 SOUDAGE AVEC ELECTRODES MMA (SMAW)	51		
5.1 PREPARATION POUR LE SOUDAGE MMA	51		
6.0 SOUDAGE TIG (GTAW)	51		
6.1 PREPARATION POUR LE SOUDAGE TIG	51		

6.2	AMORCER L'ARC PAR CONTACT (LIFT ARC)	51
7.0	SOUDAGE À FIL CONTINU MIG/MAG (FCAW), MOG (GMAW)	52
7.1.1	INSTRUCTIONS POUR LE RACCORDEMENT DE LA TORCHE A RACCORD EURO	52
7.1.2	CHARGEMENT DU FIL	52
7.1.3	REPLACEMENT DE LA GAINÉ GUIDE-FIL	53
7.1.4	COMMENT CHOISIR LA GAINÉ GUIDE-FIL.	53
7.1.5	RACCORDEMENT DE LA BOUTEILLE DU GAZ ET DU REDUCTEUR	53
7.1.6	SOUDAGE MIG SANS GAZ	53
7.1.7	SOUDAGE MIG AVEC GAZ	53
7.2	SOUDAGE MIG/MAG MANUEL	54
7.3	SOUDAGE MIG/MAG/MOG SYNERGIQUE	54
7.4	SOUDAGE DE L'ALUMINIUM	54
8.0	GUIDE POUR LES GAZ PROTECTEURS	55
9.0	SUGGESTIONS POUR LA SOUDURE ET L'ENTRETIEN	55
10.0	DETERMINATION ET ELIMINATION DES PANNES ET DES PROBLEMES	56

ESPAÑOL

1.0	NORMAS DE SEGURIDAD	58
1.1	INTRODUCCIÓN	58
1.2	SEGURIDAD PERSONAL	58
1.3	PREVENCIÓN DE LOS INCENDIOS	58
1.4	SHOCK ELÉCTRICO	59
1.5	RUIDOS	59
1.6	COMPATIBILIDAD ELECTROMAGNÉTICA	59
1.7	GASES DE PROTECCIÓN	59
2.0	RECOMENDACIONES PARA LA INSTALACIÓN	60
2.1	INSTALACIÓN	60
2.2	VENTILACIÓN	60
2.3	REQUISITOS DE LA TENSIÓN DE LA RED ELÉCTRICA	60
2.4	INSTRUCCIONES PARA LA SEGURIDAD	60
3.0	INTRODUCCIÓN	61
4.0	LA SOLDADORA	61
5.0	CONFIGURACIÓN PARA SOLDADURA STICK (MMA)	64
6.0	CONFIGURACIÓN PARA SOLDADURA TIG	64
6.1	CONEXIÓN	64
6.2	INICIO DEL ARCO CON ARRANQUE DE ELEVACIÓN (LIFT ARC)	64
7.0	SOLDADURA CON ALAMBRE CONTINUO (MIG/MAG)	64
7.1	CONEXIÓN Y PREPARACIÓN	64
7.1.1	CONEXIÓN DE LA PISTOLA	64
7.1.2	CARGA DEL ALAMBRE	64
7.1.3	SUSTITUCIÓN DEL FLEXIBLE GUÍA-ALAMBRE	65
7.1.5	CONEXIÓN CILINDRO DEL GAS Y REGULADOR	66
7.1.6	SOLDADURA MIG SIN GAS (MOG)	66
7.1.7	SOLDADURA MIG CON GAS (MAG)	66
7.1.4	ELECCIÓN DEL FLEXIBLE GUÍA-ALAMBRE	66
7.2	SOLDADURA MIG/MAG EN MODALIDAD MANUAL	67
7.3	SOLDADURA MIG/MAG EN MODALIDAD AUTOMÁTICA	67
7.4	SOLDADURA DEL ALUMINIO	67
8.0	GUÍA DE LOS GASES DE PROTECCIÓN	68
9.0	SUGERENCIAS PARA LA SOLDADURA Y EL MANTENIMIENTO	68
10.0	IDENTIFICACIÓN Y ELIMINACIÓN DE AVERÍAS E INCONVENIENTES	69



1.1 INTRODUCTION

Make sure this manual is carefully read and understood by the welder, and by the maintenance and technical workers.



1.2 PERSONAL PROTECTION

Welding processes of any kind can be dangerous not only to the operator but to any person situated near the equipment, if safety and operating rules are not strictly observed.



Arc rays can injure your eyes and burn your skin. The welding arc produces very bright ultra violet and infra red light. These arc rays will damage your eyes and burn your skin if you are not properly protected.

- Wear closed, non-flammable protective clothing, without pockets or turned up trousers, gloves and shoes with insulating sole and steel toe. Avoid oily greasy clothing.
- Wear a non-flammable welding helmet with appropriate filter lenses designed so as to shield the neck and the face, also on the sides. Keep protective lens clean and replace them when broken, cracked or spattered. Position a transparent glass between lens and welding area.
- Weld in a closed area that does not open into other working areas.
- Never look at the arc without correct protection to the eyes. Wear safety glasses with the side shields to protect from flying particles.



Gases and fumes produced during the welding process can be dangerous and hazardous to your health.

- Adequate local exhaust ventilation must be used in the area. It should be provided through a mobile hood or through a built-in system on the workbench that provides exhaust ventilation from the sides, the front and below, but not from above the bench so as to avoid raising dust and fumes. Local exhaust ventilation must be provided together with adequate general ventilation and air circulation, particularly when work is done in a confined space.
- Welding process must be performed on metal surfaces thoroughly cleaned from rust or paint, to avoid production of harmful fumes. The parts degreased with a solvent must be dried before welding.
- Be very careful when welding any metals which may contain one or more of the following:
Antimony Beryllium Cobalt Manganese Selenium Arsenic Cadmium
Copper Mercury Silver Barium Chromium Lead Nickel
Vanadium
- Remove all chlorinated solvents from the welding area before welding. Certain chlorinated solvents decompose when exposed to ultraviolet radiation to form phosgene gas (nerve gas).



1.3 FIRE PREVENTION

Fire and explosion can be caused by hot slag, sparks or the welding arc.

- Keep an approved fire extinguisher of the proper size and type in the working area. Inspect it regularly to ensure that it is in proper working order;
- Remove all combustible materials from the working area. If you can not remove them, protect them with fire-proof covers;
- Ventilate welding work areas adequately. Maintain sufficient air flow to prevent accumulation of explosive or toxic concentrations of gases;
- Do not weld on containers that may have held combustibles;
- Always check welding area to make sure it is free of sparks, slag or glowing metal and flames;
- The work area must have a fireproof floor;



1.4 ELECTRIC SHOCK

WARNING: ELECTRIC SHOCK CAN KILL!

- A person qualified in First Aid techniques should always be present in the working area; If a person is found unconscious and electric shock is suspected, do not touch the person if she or he is in contact with cable or electric wires. Disconnect power from the machine, then use First Aid. Use

-ENGLISH-

dry wood or other insulating materials to move cables, if necessary away from the person.

- Wear dry gloves and clothing. Insulate yourself from the work piece or other parts of the welding circuit.
- Make sure the main line is properly grounded.
- Do not coil the torch or the ground cables around your body.
- Never touch or come in physical contact with any part of the input current circuit and welding current circuit.

Electric warning:

- Repair or replace all worn or damaged parts.
- Extra care must be taken when working in moist or damp areas.
- Install and maintain equipment according to local regulations.
- Disconnect power supply before performing any service or repair.
- Should you feel the slightest electrical shock, stop any welding immediately and do not use the welder until the fault has been found and corrected.



1.5 NOISE

Noise can cause permanent hearing loss. Welding processes can cause noise levels that exceed safe limits. You must protect your ears from loud noise to prevent permanent loss of hearing.

- To protect your hearing from loud noise, wear protective ear plugs and/or ear muffs.
- Noise levels should be measured to be sure the decibels (sound) do not exceed safe levels.

1.6 ELECTROMAGNETIC COMPATIBILITY

Before installing your welder, carry out an inspection of the surrounding area, observing the following guidelines:

- Make sure that there are no other power supply cables, control lines, telephone leads or other equipment near the unit.
- Make sure that there are no radio receivers, television appliances, computers or other control systems near the unit.
- People with pace-maker or hearing-prosthesis should keep far from the power source.

! In particular cases special protection measures may be required.

Interference can be reduced by following these suggestions:

- If there is interference in the power source line, an E.M.T. filter can be mounted between the power supply and the power source;
- The output cables of the power source should be not too uch long, kept together and connected to ground;
- After the maintenance all the panels of the power source must be securely fastened in place.

1.7 PROTECTIVE WELDING GASES

Shielding gas cylinders contain gas under high pressure. If damaged, a cylinder can explode. Treat them carefully.

- These welders use only inert or non-flammable gases for welding arc protection. It is important to choose the appropriate gas for the type of welding being performed;
- Do not use gas from unidentified cylinders or damaged cylinders;
- Do not connect the cylinder directly to the welder, use a pressure regulator;
- Make sure the pressure regulator and the gauges function properly;
- Do not lubricate the regulator with oil or grease;
- Each regulator is designed for use with a specific gas. Make sure the regulator is designed for the protective gas being used;
- Make sure that the cylinder is safely secured tightly to the welder with the chain provided.
- Never expose cylinders to excessive heat, sparks, slag or flame;
- Make sure that the gas hose is in good condition;
- Keep the gas hose away from the working area.

2.0

INSTALLATION RECOMMENDATIONS



2.1 LOCATION

Be sure to locate the welder according to the following guidelines:

- In areas, free from moisture and dust;
- Ambient temperature between 0° to 40°C;
- In areas, free from oil, steam and corrosive gases;
- In areas, not subjected to abnormal vibration or shock;
- In areas, not exposed to direct sunlight or rain;
- Place at a distance of 300mm or more from walls or similar that could restrict natural air flow for cooling

2.2 VENTILATION

Since the inhalation of welding fumes can be harmful, ensure that the welding area is effectively ventilated.

2.3 MAIN SUPPLY VOLTAGE REQUIREMENTS

Before you make any electrical connection, check that supply voltage and frequency available at site are those stated in the ratings label of your generator.

The main supply voltage should be within $\pm 10\%$ of the rated main supply voltage. Too low a voltage may cause poor welding performance. Too high a supply voltage will cause components to overheat and possibly fail. The welder Power Source must be:

- Correctly installed, if necessary, by a qualified electrician;
- Correctly grounded (electrically) in accordance with local regulations;
- Connected to the correct size electric circuit.

In case the supply cable is not fitted with a plug, connect a standardized plug (3P+T) to the supply cable (in some models the supply cable is supplied with plug).

To connect the plug to the supply cable, follow these instructions:

- the brown (phase) wire must be connected to the terminal identified by the letter L1
- the blue or grey wire must be connected to the terminal identified by the letter L2
- the black or grey wire must be connected to the terminal identified by the letter L3
- the yellow/green (ground) wire must be connected to the terminal identified by the letter PE or by the symbol \perp .

In any case, the connection of the yellow/green wire to the PE terminal \perp must be done in order that in the event of tearing of the power supply cable from the plug, the yellow/green wire should be the last one to be disconnected.

The outlet should be protected by the proper protection fuses or automatic switches.

Notes:

- Periodically inspect supply cable for any cracks or exposed wires. If it is not in good conditions, have it repaired by a Service Centre.
- Do not pull violently the input power cable to disconnect it from supply.
- Do not squash the supply cable with other machines, it could be damaged and cause electric shock.
- Keep the supply cable away from heat sources, oils, solvents or sharp edges.
- In case you are using an extension cord, try to keep it well straight and avoid its heating up.

2.4 SAFETY INSTRUCTIONS

For your safety, before connecting the power source to the line, closely follow these instructions:

- An adequate two-pole switch must be inserted before the main outlet; this switch must be equipped with time-delay fuses;
- The connection with ground must be made with a two-pole plug compatible with the above mentioned socket;
- When working in a confined space, the power source must be kept outside the welding area and the ground cable should be fixed to the workpiece. Never work in a damp or wet area, in these conditions.
- Do not use damaged input or welding cables
- The welding torch should never be pointed at the operator's or at other persons' body;
- The power source must never be operated without its panels; this could cause serious injury to the operator and could damage the equipment.

3.0

INTRODUCTION

This manual was edited to give some indications on the operation of the welder and was thought to offer information for its practical and safe use. Its purpose is not to teach welding techniques. All suggestions are indicative and intended to be only guide lines.

To ensure that your welder is in good conditions, inspect it carefully when you remove it from its packing having care to ascertain that the cabinet or the stocked accessories are not damaged.

Your welder is capable of daily activity metal fabrication and maintenance. Its simplicity and versatility and its excellent welding characteristic are the product of the most up to date inverter technology. This welding inverter offers the welder the ability to create precise arc characteristics and at the same time reduce consumption of energy with respect to the welders based on a traditional transformer.

Respect the duty cycle of the welder making reference to the technical data label on the welder's back. Duty cycle is given as percentage on a 10 minute time. During this period of time the unit can be used at the rated duty cycle. Exceeding the rated duty cycle may cause overheating or welder damage.

-ENGLISH-

Welder's basic specifications:

	(3ph) 400V 50/60Hz		
Power 60%	7 KVA		
	MMA	TIG	MIG
U _o	56 V	12 V	42 V
Amp. Min-Max	25 + 200 A	5 + 270 A	30 + 270 A
Amp. 60974-1	40% 200 A 60% 155 A 100% 125 A	40% 270 A 60% 220 A 100% 170 A	40% 270 A 60% 220 A 100% 170 A
Aluminium	-	-	Ø 0,8 + 1,2
Steel	-	-	Ø 0,6 + 1,2
Flux core	-	-	Ø 0,8 + 1,2
Stainless Steel	-	-	Ø 0,8 + 1,2
Brazing	-	-	Ø 0,8 + 1,2
Ø E	1,6 + 5 mm	-	-
Insulation	H		
Protec. degree	IP22S		

Welding Wire Selection:

This welder can work with Aluminum wire 0,8 ÷ 1,2 diameter, solid steel wire 0,6 ÷ 1,2 diameter and stainless steel wire 0,8 ÷ 1,2 diameter (Gas Welding) and with flux core wires 0,8 ÷ 1,0 diameter (No Gas Welding).

Feed Rolls:

groove 0,6-0,8mm for wires 0,6-0,8mm
 groove 1,0-1,2mm for wires 1,0-1,2mm
 U-groove feed rolls for Aluminum, groove 0,8-1,0mm for wires 0,8-1,0mm
 U-groove feed rolls for Aluminum, groove 1,0-1,2mm for wires 1,0-1,2mm

Gas Selection

According to the material to be welded and to the wire you are going to use, select the shielding gas. The table below can give you some useful indications:

MATERIAL TO WELD	GAS CYLINDER	WIRE
Mild steel	Argon + CO2 or CO2	70S-6 71T1 71T11
Stainless steel	Argon + CO2 or Argon	308L 316L
Aluminum	Argon	4043 5356

4.0

KNOW YOUR WELDER

QUICK START

Your new single phase inverter multi-function welder offers **THREE WELDING FUNCTIONS** in the same power source. These functions can be selected with knob (6) on the front panel of the unit:

MIG (GMAW and FCAW) Welding with Gas and without Gas

This welder offers the choice to weld in manual or synergic mode.

1. Manual Mode: The operator is required to set both the wire speed (Left Knob - 8-) and the welding voltage (Right Knob - 7-).
2. Synergic Mode: the operator is required to simply set the thickness of the material to be welded (Right Knob -7-). Once this parameter is set, the synergic function automatically adjusts the welding voltage and the wire speed allowing the operator to balance this last value simply adjusting the Left Knob (8).

Stick Welding (SMAW)

Both rutile and basic electrodes can be welded. Welding current is adjusted using the Left Knob (8).

TIG welding (GTAW)

In the TIG position, a TIG torch with a gas valve in the handle is required. The gas valve must be opened manually before welding and closed manually when welding is completed. The arc is activated by contact. Using the Left Knob (8) welding current can adjusted.

-ENGLISH-

CONTROLS AND OPERATIONAL FEATURES

Figure 1

Figure 2

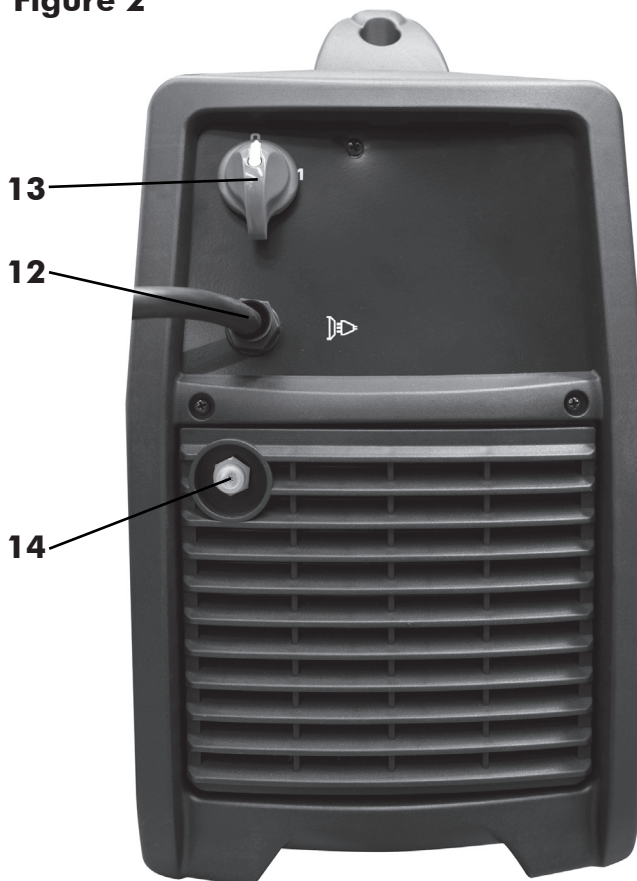
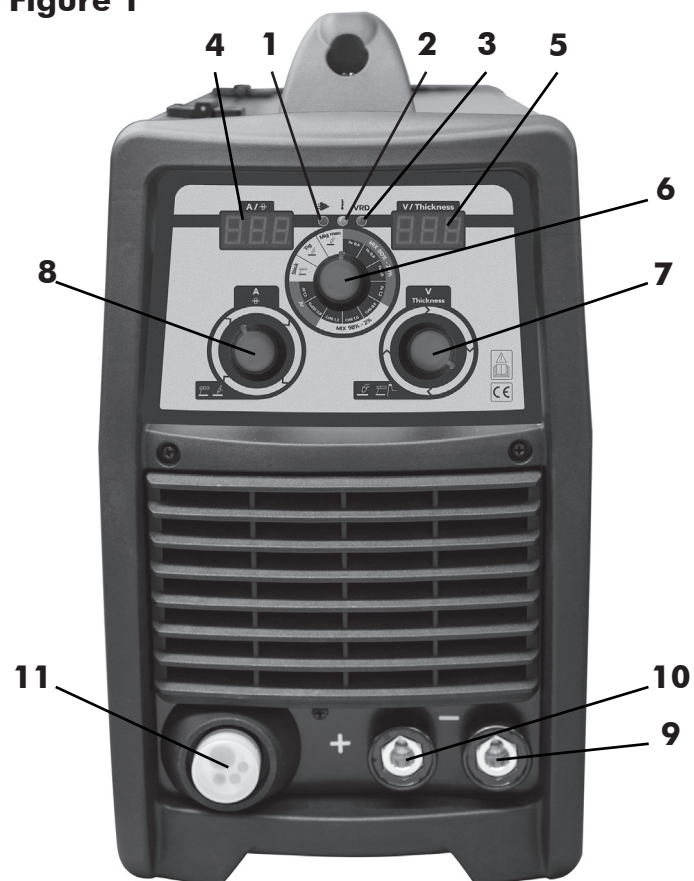

1. Power switch indicator: This green LED lights when the welding machine is ON and is ready to work. In the event of an overvoltage supply the green LED blinks and the red LED (3) is ON.
2. Thermal overload indicator: If the yellow LED is ON it indicates that the welder has overheated and the machine has automatically shut down. This may be a result of having exceeded the welders duty cycle or that normal cooling air flow has been interrupted. Check to confirm that the cooling fan is running and that air flow is not blocked. Do not turn off the welder as this will stop the cooling fan. When the welder has cooled sufficiently the yellow LED will go out and the welder is ready to weld.
3. Alarm indicator: This red LED lights when there is a working abnormality such as an over voltage supply.
4. Left Display: During welding it displays the actual value of the output current (AMP). When the machine is not welding, (no load), the display shows the value of the parameter selected with the Left Knob (8):
 - a. In STICK and TIG mode it shows the selected current value.
 - b. In MIG MANUAL mode the display shows the selected wire speed in m/min.
 - c. In MIG SYNERGIC mode the display shows wire speed balance; possible variation is +/-40% on the base value adjusted by default ("0" on the display, central position).
5. Right Display: during welding it displays the actual arc voltage. When the machine is not welding (no load) it displays the value of the parameter adjusted with the Right Knob (7):
 - a. in STICK mode it displays the Hot Start over-current value expressed as a percentage of the base welding current selected with the left knob (8). The over current value is variable from 0 to 50% of the base current. Maximum Hot start value of 50% can be adjusted up to 120Amp of welding current. On the display the value of Hot Start is shown as "H" and the value of the over current in %.
 - b. In TIG Mode the display is not active.
 - c. In MIG MANUAL it displays the selected arc voltage from 12V to 35V.
 - d. In MIG SYNERGIC it displays the thickness of the material to be welded expressed in mm.
6. Selector switch for the Welding Modes Selection: MMA, TIG, MIG manual, MIG Syn.
7. Right Knob: it is used to adjust the following welding parameters.
 - a. in STICK Mode it adjusts the over-current value of the electric arc (Hot Start), variable from 0 to 50% on the current value adjusted with the Left Knob (8).
 - b. In TIG Mode is not active.
 - c. In MIG manual it adjusts arc voltage value (no load) from 12V to 35V.
 - d. In MIG Synergic it selects the thickness of the material to be welded.

-ENGLISH-

8. Left Knob: it is used to adjust the following welding parameters.
 - a. In STICK Mode it adjusts the current value from a minimum of 25Amp to a maximum of 200Amp.
 - b. In TIG Mode, it adjusts the current value from a minimum of 5 Amp to a maximum of 270Amp.
 - c. In MIG manual it adjusts the wire speed.
 - d. In MIG Syn it adjusts the wire speed; possible variation is +/-40% on the base value adjusted by default ("0" on the display).
9. Negative Dinse socket:
 - a. in STICK welding for the connection of the ground cable connector (check for correct polarity for the electrode you are going to use, refer to the information on its box);
 - b. in TIG Welding for the TIG torch cable connection;
 - c. in MIG welding (with gas) for the connection of the ground cable connector.
10. Positive Dinse socket:
 - a. in STICK welding, for the connection of the ground cable connector (check for correct polarity for the electrode you are going to use, refer to the information on its box);
 - b. in MIG Flux Core Welding (FCAW), for the connection of the ground cable connector
11. Euro connect for attaching the MIG torch cable. In MIG Flux Core welding (FCAW), change the polarity of the Euro socket using the terminals on the polarity change board located inside the wire spool compartment above the wire feeder -18-).
12. Input power cable
13. ON/OFF Switch
14. Gas Hose connector
15. 2 roll Aluminum wire feeder
16. Slope up Time regulation potentiometer
17. Burn Back Time Regulation Potentiometer (B.B.T.)
18. Polarity Change Terminals for the Euro Socket:
 - a. positive polarity for MIG/MAG Welding;
 - b. negative polarity for No Gas Welding.
19. Spool holder for wire spools

Figure 3

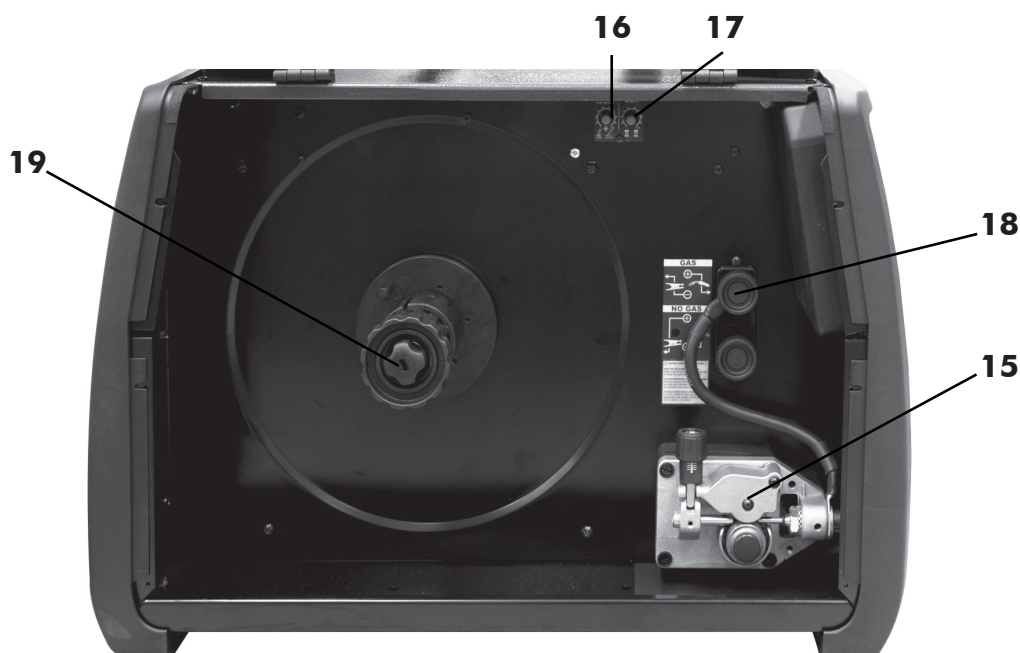

5.0 STICK ELECTRODE WELDING (SMAW)

5.1 GETTING READY FOR STICK ELECTRODE WELDING (SMAW).

- Select the Stick function (SMAW) with the Selector Switch (6) on the front panel.
- Check the electrode packaging to determine the recommended polarity and connect the Electrode holder and ground clamp to the plus and minus Dinse sockets accordingly.
- Switch the unit ON thru the ON/OFF switch (13).
- Set the welding current with the Left Knob (8) on the front panel and the strike over-current value of the electric arc (Hot Start) with the Right Knob (7).

Adjustable Welding current: Min 25Amp – Max 200 Amp

6.0 TIG WELDING WITH LIFT START (GTAW)

6.1 SETTING UP THE EQUIPMENT FOR TIG WELDING

- Select the TIG function on the control panel with knob (6).
- Connect the TIG torch cable to the negative dinse socket (9) of the welder.
- Connect the ground cable connector to the positive dinse socket (10) of the welder.
- Connect the TIG torch gas line to the gas regulator, ARGON GAS ONLY
- Switch the unit ON thru the ON/OFF switch (13).

The gas flow is manually controlled with the knob on the TIG torch. Use inert gas (argon) only.

CLOSE THE GAS VALVE ON THE TORCH HANDLE. Turn on gas at the gas regulator, then open the valve on the torch handle and check for gas flow.

6.2 STARTING THE ARC BY CONTACT (LIFT ARC)

- Fix the tungsten electrode so that it protrudes approximately 4-5mm from the torch nozzle.
- Set the welding current with the Left Knob (8).
- Position the torch at a distance of 3-4mm so with the nozzle in contact with the work piece at a 45 degree angle.
- With a rapid movement short - circuit the tungsten electrode and go back to a distance of 3-4 mm. Advance the torch maintaining the same distance from the work piece. To stop welding, simply remove the torch from the work piece.

REMEMBER to turn OFF the gas immediately after you finish welding.

Adjustable Welding current: Min 5Amp – Max 270 Amp

7.0 MIG (GMAW) AND FLUX CORE (FCAW) WELDING

7.1.1 TORCH CONNECTION

- Plug the torch hose into the socket (9) on the front of the welder having care to not damage the contacts and secure by hand screwing in the threaded connection.

7.1.2 WIRE LOADING

! Ensure the gas and electrical supplies are disconnected. Before proceeding, remove the nozzle and the contact tip from the torch.

- Open the side panel.

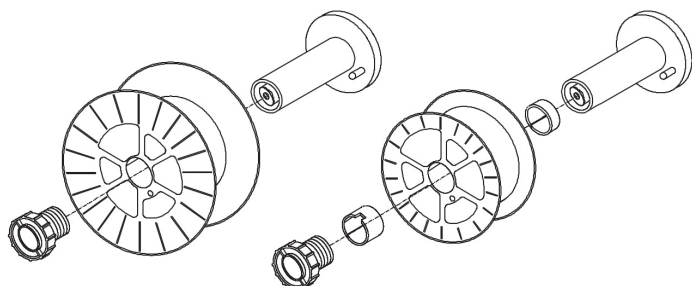

Figure 4

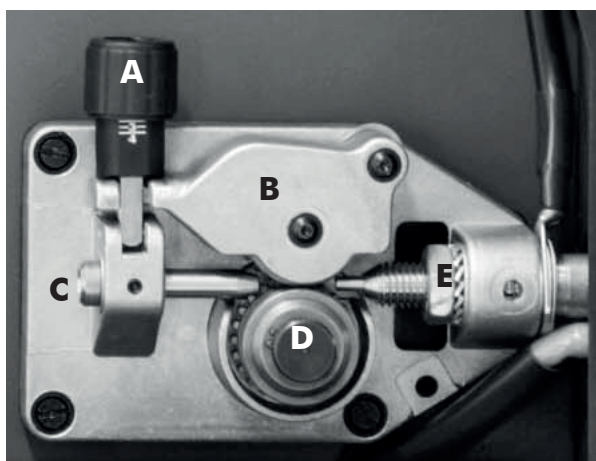

Figure 5

- Loosen the nut of the spool holder (brake-drum). (Fig.4)
 - Remove the plastic protection from the spool and place the wire spool on the spool holder. Mount the plastic lock nut again. This is the braking system of the wire spool speed. NOTE: Do not tighten the nut too much, excessive pressure strains the wire feeding motor, while too little pressure does not allow the immediate stop of the wire spool at the end of the welding.
 - Loosen and lower the plastic knob (A) (Fig.5). Open the pressure arm (B) of the feeder.
 - Disconnect the wire from the edge of the wire spool being careful to keep tension on the end of the wire.
 - Cut off a short section of the end of the wire to insure a straight end. Insert the the straight end into the wire inlet guide (C) past the wire feed roll and into the wire liner.
 - Lower pressure arm (B) and lift pressure adjustment knob (A) into place.
 - Connect the input power cord and turn on the welder.
 - Press the torch trigger and observe the wire feeding into the torch liner.
 - Adjust the pressure on the wire with knob (A) to insure smooth feeding without slippage. Do not over tighten the pressure adjustment as it may damage the motor.
 - Close the welder side panel.
- Remove the nozzle and contact tip from the welding torch.
 - Straighten the torch cable to remove any coils or kinks.
 - Squeeze and hold the torch trigger until the wire appears at the end of the torch neck.
 - Turn off the welder and install the contact tip and nozzle.

! **WARNING:** keep the torch straight. When feeding a new wire through the liner, make sure the wire is cut cleanly (no burrs or angles) and that at least 2 cm from the end is straight (no curves). Failure to follow these instructions could cause damage to the liner.

! **WARNING:** When changing the wire diameter being used, or replacing the wire feed roll, be sure that the correct groove for the wire diameter selected is inside, closest to the machine. The wire is driven by the inside groove. Feed rolls are marked on the side identifying the groove nearest that side.

! **WARNING:** When loading wire and watching for it to come through the torch neck, to avoid injury, do not hold the torch close to your face, instead, direct the wire toward the floor. To avoid injury, do not place fingers near the wire feed rolls when the wire feeder is operating.

-ENGLISH-

7.1.3 REPLACING THE WIRE LINER

Ensure the gas and electrical supplies are disconnected.

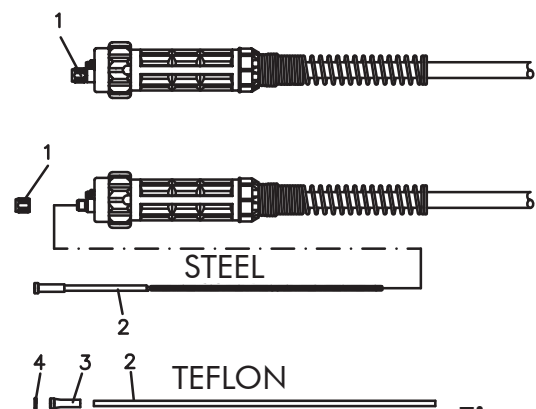

Figure 6

- Disconnect the torch from the machine.
 - Place it on a flat surface and carefully remove the brass nut (1).
 - Pull the liner out of the hose.
 - Install the new liner and mount the brass nut (1) again.
- In case you are replacing a Teflon wire liner, follow these instructions:

- Install the new liner followed by the collet (3).
- Insert the O ring (4) on the wire liner collet (4) and replace the brass nut (1).
- Cut the wire liner close to the brass nut



Warning: the length of the new wire liner must be the same of the liner you have just pulled out of the hose.

- Connect the torch to the machine and install the wire into the feeding system.

7.1.4 HOW TO CHOOSE THE WIRE LINER

Mainly we can have 2 types of wire liners: Steel wire liners and Teflon wire liners.

- The steel wire liners can be coated or not coated: the coated wire liners are used for air cooled torches; the wire liners which are not coated are used for water cooled torches.
- The Teflon wire liners are suggested for the welding of Aluminium, as they allow a smooth feeding of the wire.

Colour	BLUE	RED	YELLOW
Diameter	Ø 0,6-0,9	Ø 1,0-1,2	Ø 1,2-1,6

7.1.5 GAS CYLINDER AND REGULATOR CONNECTION



WARNING: Cylinders are highly pressurized. Handle with care. Serious accidents can result from improper handling or misuse of compressed gas cylinders. Do not drop the cylinder, knock it over, expose it to excessive heat, flames or sparks. Do not strike it against other cylinders.

The gas cylinder (not supplied) should be located at the rear of the welder, in a well ventilated area and securely fixed to the work bench or to the wall to insure that it will not fall. For safety, and economy, ensure that the regulator is fully closed, (turned counter-clockwise) when not welding and when installing or removing the gas cylinder.

- Turn the regulator adjustment knob counter-clock wise to ensure the valve is fully closed.
- Install the gas regulator on the gas cylinder, tighten the connecting nut firmly to insure against gas leakage.
- Connect the gas hose to the gas regulator.
- Open the cylinder valve, then set the gas flow to approx. from 5 to 15l/min. on the regulator.

7.1.6 FLUXCORE WIRE WELDING, "FCAW"

- Connect the ground cable to the positive terminal of the Polarity Change Board inside the spool compartment.
- Connect the working cable to the negative terminal of Polarity Change Board inside the spool compartment.

7.1.7 MIG WELDING, "GMAW"

- Connect the ground cable to the negative terminal on the Polarity Change Board inside the spool compartment.
- Connect the working cable to the positive terminal of the Polarity Change Board inside the spool compartment.



Figure 7

-ENGLISH-

7.2 MIG / NO GAS MANUAL WELDING (REF. FIGURE 1)

Before connecting the unit to the mains, verify that all the accessories are correctly installed and mounted for electric welding (torch, wire spool etc ...).

- Select Manual MIG Welding function with the Selector Switch (6) on the front panel.
- Switch the unit ON thru the ON/OFF switch (13) on the back side of the unit.
- Press the torch trigger to load the wire.
- Set the welding parameters:
 1. Wire feed speed: use Left Knob (8) to adjust the wire speed expressed in mm on the Left Display (4).
 2. Arc voltage: use the Right Knob (7) to adjust arc voltage value (no load) from 12V to 35V.
- Bring the torch close to the work piece and press the trigger
 1. Wire feeder Slope-Up Time (Min. to Max. speed transition time), adjustable with the potentiometer located inside the access panel (16).
 2. At the end of the Slope-Up Time, the wire feed speed reaches the value adjusted with the Left knob (8).
- To stop welding, release the trigger. The arc stays ON accordingly to the set B.B.T. (Burn back time). B.B.T. is the amount of time that the weld output continues after the wire stops feeding. It prevents the wire from sticking in the puddle and prepares the end of the wire for the following arc start.

7.3 SYNERGIC MIG WELDING (REFER TO FIGURE 1)

- Select the MIG Syn function thru the Selector Switch (6) on the front panel.
- MIG Synergy functions permits the operator to get the optimal welding parameters simply setting the thickness of the material to be welded (Right Knob -7-). Once this parameter is set, the synergic function automatically adjusts the welding voltage and the wire speed allowing the operator to balance this last value if necessary with the Left Knob (8).
- Switch the unit ON thru the ON/OFF switch (13) on the back side of the unit.
- Press the torch trigger to load the wire and check that the gas is flowing from the welding torch.
- Select the thickness of the material to be welded using the Right Knob (7).
- Adjust the wire speed using the Left Knob (8) if necessary. Possible variation is +/-40% on the base value adjusted by default ("0" on the display). Bring the torch close to the work piece and press the trigger.
 1. Wire feeder Slope-Up Time (Min. to Max. speed transition time), adjustable with the potentiometer located inside the access panel (16).
 2. At the end of the the Slope-Up Time, the wire feed speed reaches the value adjusted with the Left knob (8).
- To stop welding, release the trigger. The arc stays ON accordingly to the set B.B.T. (Burn back time). B.B.T. is the amount of time that the weld output continues after the wire stops feeding. It prevents the wire from sticking in the puddle and prepares the end of the wire for the following arc start.

7.4 ALUMINUM WELDING

The machine needs to be set up as follows:

- 100% ARGON as welding protective gas.
- Ensure that your torch is set up for aluminum welding:
 1. The lenght of the torch should not exceed 3m (it is advisable not to use longer torches).
 2. Install a teflon wire liner (follow the instructions for the replacing of the wire liner).
 3. Use contact tips that are suitable for aluminum wire and make sure that the diameter of the contact tip hole corresponds to the wire diameter that is going to be used.
- Ensure that drive rolls are suitable for aluminum wire.

8.0 PROTECTION GASES GUIDE

METAL	GAS	NOTE
Mild steel	CO2 80/82% Argon + 20/18% CO2 Argon + CO2 + Oxygen	Argon controls spatters Oxygen improves arc stability
Aluminium	Argon Argon + Helium	Arc stability, good fusion and minimum spatter. Higher heat input suitable for heavy sections. Minimum porosity.
Stainless steel	Argon + CO2 + Oxygen Argon + Oxygen	Arc stability. Minimum spatter.
Copper, Nickel and Alloys	Argon Argon + Helium	Suitable for light gauges because of low flowability of the weld pool. Higher heat input suitable for heavy sections.

Contact the technical service of your gas supplier to know the percentages of the different gases which are the most suitable to your application.

9.0 WELDING HINTS AND MAINTENANCE

- Always weld clean, dry and well prepared material.
 - Hold gun at a 45° angle to the workpiece with nozzle about 5 mm from the surface.
 - Move the gun smoothly and steadily as you weld.
 - Avoid welding in very drafty areas. A weak pitted and porous weld will result due to air blowing away the protective welding gas.
 - Keep wire and wire liner clean. Do not use rusty wire.
 - Sharp bends or kinks on the welding cable should be avoided.
 - Always try to avoid getting particles of metal inside the machine since they could cause short circuits.
 - If available, use compressed air to periodically clean the hose liner when changing wire spools
- IMPORTANT: Disconnect from power source when carrying out this operation.**
- Using low pressure air (3/5 Bar=20-30 PSI), occasionally blow the dust from the inside of the welder. This keeps the machine running cooler. Note: do not blow air over the printed circuit board and electronic components.
 - The wire feed roller will eventually wear during normal use. With the correct tension the pressure roller must feed the wire without slipping. If the pressure roller and the wire feed roller make contact (when the wire is in place between them), the wire feed roller must be replaced.
 - Check all cables periodically. They must be in good condition and not cracked.

This chart will assist you in resolving common problems you may encounter. These are not all the possible solutions.

PROBLEM	POSSIBLE CAUSE	POSSIBLE SOLUTION
No "life" from welder	Input cable, plug or main switch malfunction. Wrong size fuse.	Check for proper input cable connection Check fuse and replace as necessary
Fan operates normally, but when gun trigger pulled, there is no wire feed, weld output or gas flow	Faulty trigger on gun Thermostat intervention	Replace torch trigger Allow welder to cool. The extinguishing of the pilot lamp / switch on the front panel indicates the thermostat has closed.
Feed motor operates but wire will not feed	Wrong contact tip diameter. Faulty wire feeding motor (rare) Insufficient feed roller pressure Burr on end of wire Liner blocked or damaged. Contact tip clogged or damaged.	Check that the contact tip diameter is correct for the loaded welding wire. Replace wire feeding motor Increase roller pressure Re-cut wire square with no burr Clear with compressed air or replace liner. Replace contact tip.
Lack of penetration	Voltage or wire feed speed too low. Loose connection inside the machine (rare). Worn or wrong size contact tip. Loose gun connection or faulty gun assembly. Undersized or damaged earth cable. Wrong size wire. Wire inside the liner is not well stretched. Torch moved too fast.	Re-adjust the welding parameters or select the Synergy Mode. Clear with compressed air and tighten all connections. Replace the contact tip. Tighten or replace torch. Replace the earth cable. Use correct size welding wire. Load again the welding wire ensuing it is well stretched and without creases. Move the gun smoothly and not too fast.
Wire is birdnesting at the drive roller	Excessive pressure on drive roller. Gun liner worn or damaged. Contact tip clogged or damaged. Liner stretched or too long.	Adjust pressure on drive roller. Replace wire liner. Replace contact tip. Cut wire liner at the right length.
Wire burns back to contact tip	Contact tip clogged or damaged. Wire feed speed too slow or arc voltage too high.	Replace the contact tip. Increase wire speed or decrease arc voltage.

-ENGLISH-

	Wrong size contact tip.	Use correct size contact tip.
	BBT time is too long.	Adjust BBT time with the potentiometer located on the spool compartment (17).
Workpiece clamp and/or cable gets hot.	Bad connection from cable to clamp.	Tighten connection or replace cable.
	Bad connection between clamp and workpiece.	Clean and/or strip the workpiece on the point of contact with the clamp.
Gun nozzle arcs to work surface.	Slag buildup inside nozzle or nozzle is shorted.	Clean or replace nozzle.
Wire pushes torch back from the workpiece	Wire feed speed too fast.	Decrease wire feed speed or adjust Slope Up.
Poor quality welds	Voltage too low.	Increase the voltage by acting on the regulation potentiometer (7).
	Clogged nozzle.	Clean or replace nozzle
	Torch held too far from the workpiece	Hold the torch at the right distance
	Insufficient gas at weld area	Check that the gas is not being blown away by drafts and if so move to more sheltered weld area. If not check gas cylinder contents gauge, regulator setting and operation of gas valve.
	Rusty, painted, damp, oil or greasy workpiece	Ensure workpiece is clean and dry.
	Rusty or dirty wire	Ensure wire is clean and dry.
	Poor ground contact	Check ground clamp/workpiece connection
	Incorrect gas / wire combination	Check on the manual for the correct combination
Weld deposit "stringy" and incomplete	Torch moved over workpiece too quickly	Move the torch slower
	Gas mixture incorrect	See shielding gas table
Weld deposit too thick	Torch moved over workpiece too slowly	Move the torch faster
	Welding voltage too low	Increase welding voltage

